



**Surface Mounted
Adjustable & Preset "Back-Check"
CL8600BF/CL8600BFDA
Non Hold-Open/Hold-Open**



**Surface Mounted
Adjustable & Preset "Back-Check"
CL8600BF/CL8600BFDA
Non Hold-Open/Hold-Open**

CLOSER ADJUSTMENT

NOTE: Closing arcs ("CLOSE" and "LATCH") are controlled by two(2) separate speed adjusting valves adjust the CLOSING speed first, then adjust the LATCH speed.

- "CLOSING" speed adjustment is accomplished by full rotations of the speed adjusting valve.
 - Turn the speed adjusting valve CLOCKWISE for a SLOWER CLOSE arc closing speed.
 - Turn the speed adjusting valve COUNTER-CLOCKWISE for a FASTER CLOSER arc closing speed.
- "LATCH" speed adjustment is accomplished by full rotations of the speed adjusting valve.
 - Turn the speed adjusting screw clockwise for a SLOWER latch arc closing speed.
 - Turn the speed adjusting screw COUNTER-CLOCKWISE for a FASTER Latch arc closing speed.

CAUTION!! Do not turn speed adjusting valve more than two(2) full turns counter-clockwise from its factory set position, as two speed adjusting valves could become dislodged from the door closer body, resulting in the loss of internal fluid and failure of the device.

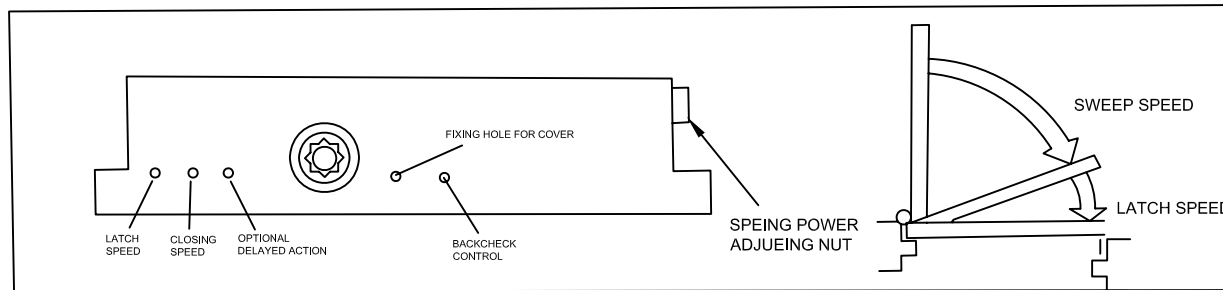

Installation Instructions for REGULAR ARM (PULL SIDE) Mounting

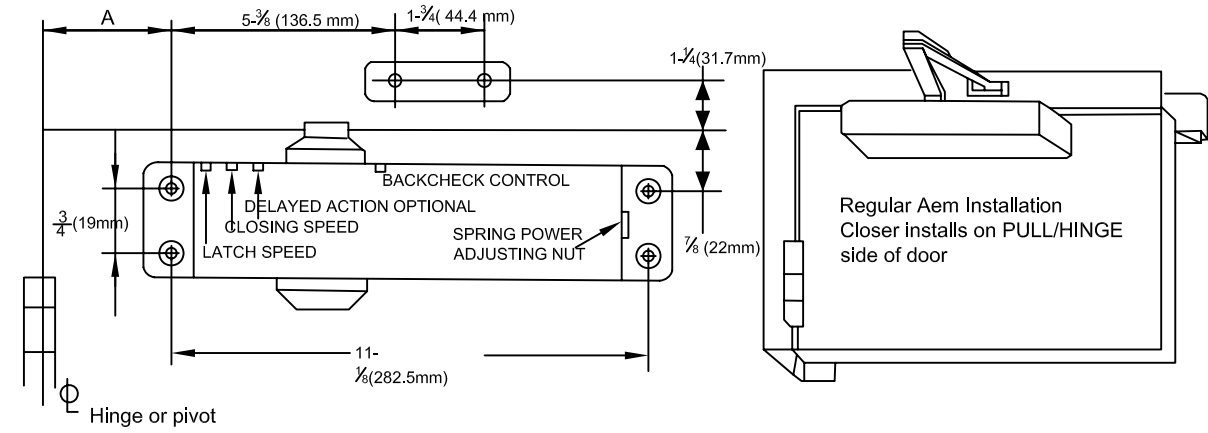

OPENING	DIM.A
TO 120°	7-3/2(180mm)
120°-180°	3-13/16(100mm)

- Right hand door shown
- Left hand door opposite
- Dimensions are in inches
- Do not scale drawing

BACK CHECK CONTROL

- To increase back check intensity, turn back check control valve clockwise.
- To decrease back check intensity, turn back check control valve anticlockwise.

SPRING POWER CONTROL

- To increase opening force and closing force, turn the spring adjusting nut clockwise.
- To decrease opening force and closing force, turn the spring adjusting nut anticlockwise.

OPENING CYCLE

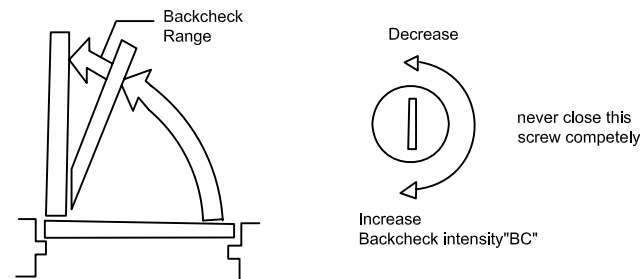

ADJUSTABLE SPRING MODELS

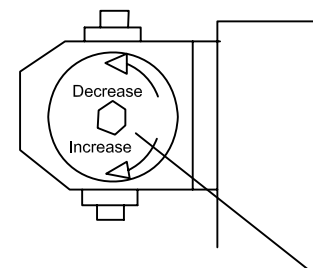

NOTE: MAXIMUM ADJUSTMENT IS APPROXIMATELY 10 TURNS DO NOT FORCIBLY EXTEND ADJUSTMENT BEYOND LIMITS

FULLY ADJUSTABLE SPRING

8600 SERIES CLOSERS ARE SHIPPED SIZE 3 ON ROTATE SPRING ANDJUSTMENTNUT COUNTERLOCKWISE TO REDUCE THE SIZE. ROTATE SPRING ADJUSTMENT NUT CLOCKWISE TO INCREASE SPRING POWER.

SPRING POWER ADJUSTMENT			
Exterior doors	Interior doors	Full turns required	Spring Power Rating
32" (0,81m)	28" (0,71m)	-5 TURNS C.C.W	1
36" (0,91m)	32" (0,81m)	-3 TURNS	2
42" (1,07m)	36" (0,91m)	0 TURNS C.W	3
48" (1,22m)	42" (1,07m)	3 TURNS C.W	4
54" (1,37m)	48" (1,22m)	6 TURNS C.W	5
58" (1,47m)	54" (1,37m)	9 TURNS C.W	6

-5 Means 5 turns counterclockwise
3 Means 3 turns clockwise

INSTALLATION INSTRUCTIONS

1. Select degree of opening from table and use template dimensions shown in above, mark six(4) HOLES ON FRAME for closer and Two(2) HOLES ON DOOR for arm shoe.
2. Drill pilot holes in door and frame for #14 all-purpose screws of drill and tap for 1/4-20 machine screws.
3. Install adjustable forearm/arm shoe assembly to door frame using screws provided.
4. Install main arm to top pinion shaft using screw provided.
5. Mount closer body on frame using screw provided. SPRING POWER ADJUSTING NUT MUST BE POSITIONED AWAY FROM HINGE EDGE.
6. Adjust length of adjustable forearm so that adjustable forearm is perpendicular to door when assembled. to preloaded main arm (illustration below). Secure forearm to main arm with screw provided.
7. Snap pinion cap over shaft on top of closer. (When using full cover, pinion cap is not necessary)
8. Adjust closing speed, back check control and spring power of door, following instructions as shown page 4.

Top View Typical Installation

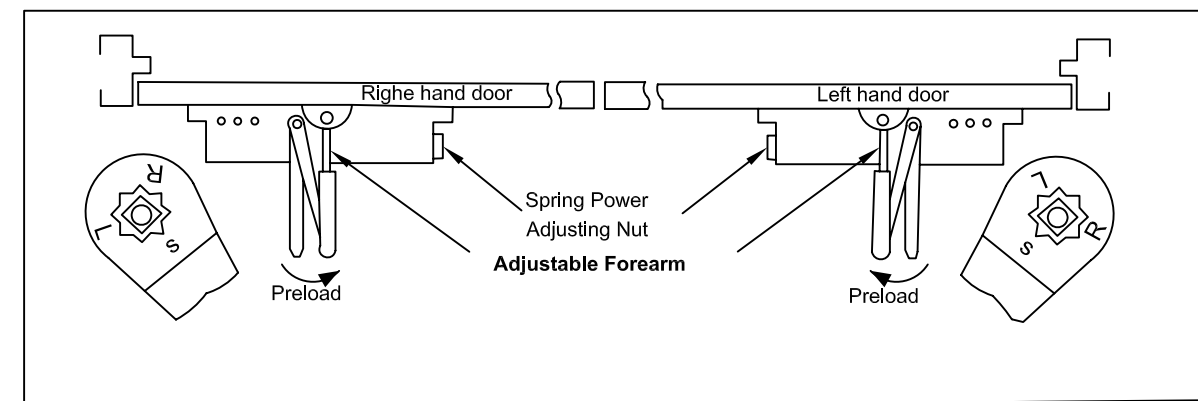



**Surface Mounted
Adjustable & Preset "Back-Check"
CL8600BF/CL8600BFDA
Non Hold-Open/Hold-Open**



**Surface Mounted
Adjustable & Preset "Back-Check"
CL8600BF/CL8600BFDA
Non Hold-Open/Hold-Open**

Installation Instructions for TOP JAMB(PUSH SIDE) Moubting

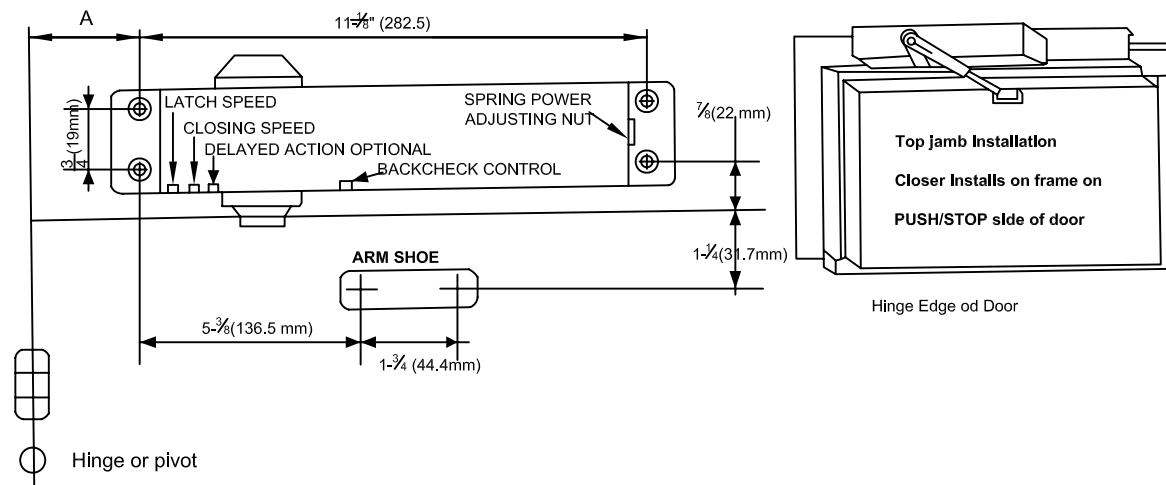

OPENING	DIM.A
TO 120°	7-3/32(180mm)
120°-180°	3-15/16(100 mm)

- Left hand door shown
- Right hand door opposite
- Dimensions are in inches
- Do not scale drawing

Installation Instructions for PARALLEL ARM(PUSH SIDE) Mounting

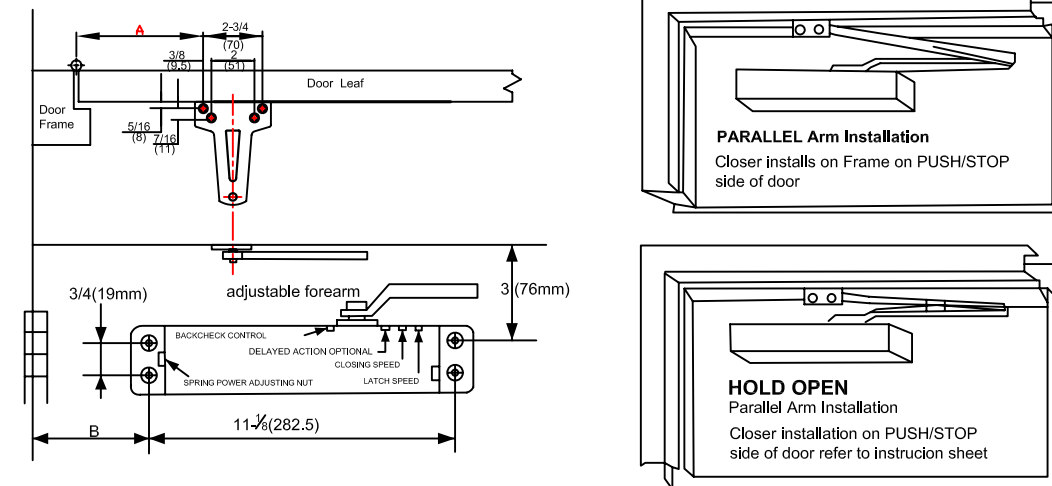

OPENING	DIM.A	DIM.B
TO 100°	9-1/8(241mm)	6-1/8(151mm)
120°-180°	5-7/8(149.2mm)	2-9/16(65mm)

- Left hand door shown
- Right hand door opposite
- Dimensions are in inches
- Drawing not to scale

INSTALLATION INSTRUCTIONS

1. Select degree of opening from table and use template dimensions shown in above, mark six (4) HOLES ON FRAME for closer and two (2) HOLES ON DOOR for arm shoe.
2. Drill pilot holes in door and frame for #14 all-purpose screws of drill and tap for 1/4-20 machine screws.
3. Install adjustable forearm/arm shoe assembly to door using screws provided.
4. Install main arm to top pinion shaft using screw provided.
5. Mount closer body on frame using screw provided. SPRING POWER ADJUSTING NUT MUST BE POSITIONED AWAY FROM HINGE EDGE.
6. Adjust length of adjustable forearm so that adjustable forearm is perpendicular to door when assembled.
7. Snap pinion cap over shaft on top of closer. (When using full cover, pinion cap is not necessary)
8. Adjust closing speed, back check control and spring power of door, following instructions as shown page 4.

Top View Typical Installation

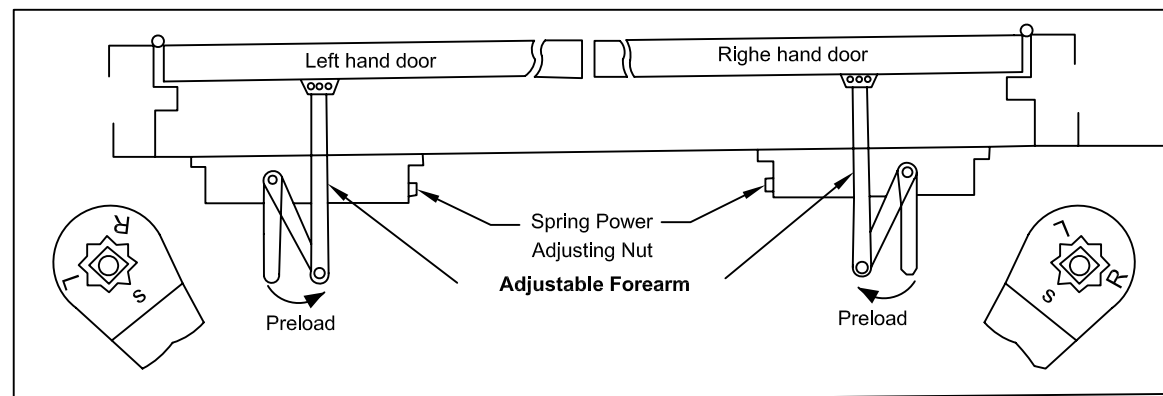

INSTALLATION INSTRUCTIONS

1. Select degree of opening from table and use template dimensions shown in above, mark six (4) holes on door for door closer and four (4) holes underside of frame for bracket.
2. Drill pilot holes in door and frame for #14 all-purpose screws of drill and tap for 1/4-20 machine screws.
3. Mount closer on door using screws provided. SPRING POWER ADJUSTING NUT MUST BE POSITIONED TOWARD HINGE EDGE.
4. Install parallel Arm Bracket to frame using screws provided.
5. Using a wrench on the square shaft at bottom of closer, rotate shaft approximately 45° toward hinge edge of door. Hold and place main arm of shaft on top of closer at proper index mark as illustrated. FOR LEFT HAND DOOR "L" (illustration "A"). FOR RIGHT HAND DOOR "R" (illustration "B"). Tighten arm screw with lockwasher securely.
6. Remove arm shoe from the forearm and discard (arm shoe is not used for parallel installation) and tighten screw securely.
7. Adjust length of adjustable forearm so that adjustable forearm is parallel to frame.
8. Snap pinion cap over shaft at bottom closer (When using full cover, pinion cap is not necessary)
9. Adjust closing speed, back check control and spring power of door, following instructions shown page 4.

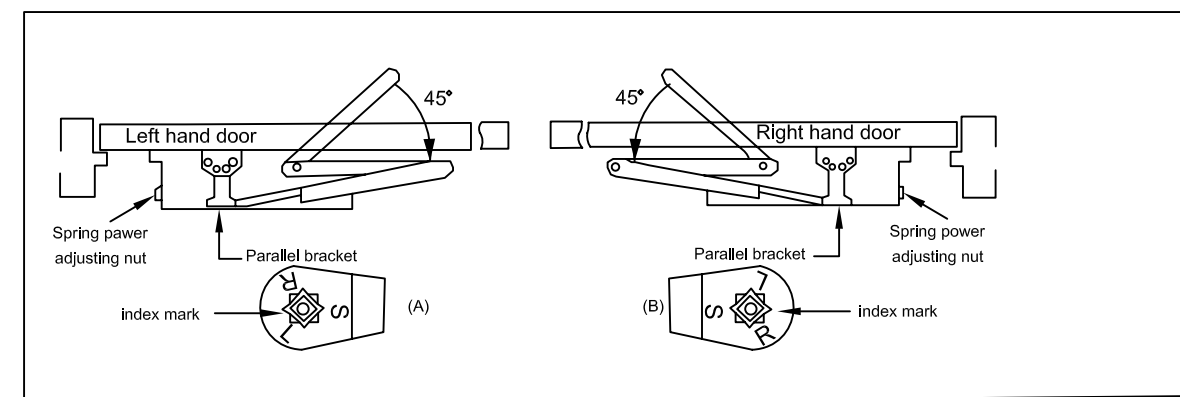

**REGULAR ARM APPLICATION (APLICACION REGULAR)
 TEMPLATE FOR A RIGHT HAND DOOR
 (GUIA DE INSTALACION PARA PUERTA DE MANO DERECHA)
 PULL SIDE (LADO DE JALAR)**

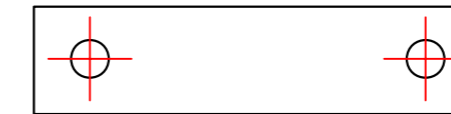

UPPER FRAME
(MARCO SUPERIOR)

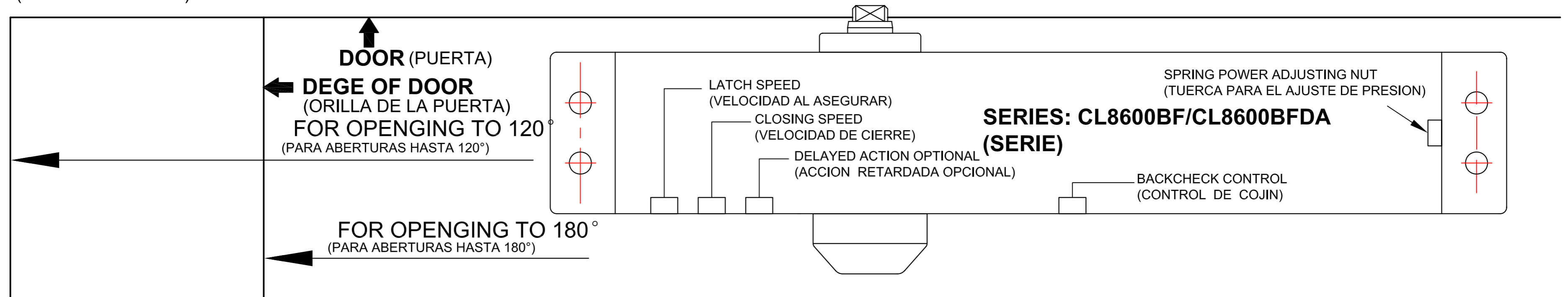

**REGULAR ARM APPLICATION (INSTALACION REGULAR)
 TEMPLATE FOR A LEFT HAND DOOR
 (GUIA DE INSTALACION PARA PUERTA DE MANO IZQUIERDA)
 PULL SIDE (LADO DE JALAR)**



UPPER FRAME
(MARCO SUPERIOR)

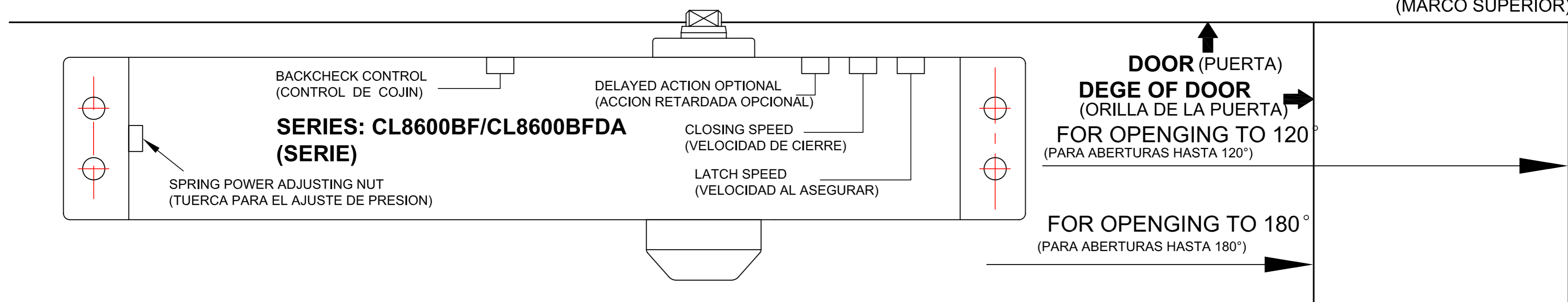

TOP JAMB APPLICATION
 (INSTALACION PARA SOPORTE SUPERIOR)
 TEMPLATE FOR A LEFT HAND DOOR
 (GUIA DE INSTALACION PARA PUERTA DE MANO IZQUIERDA)
 PUSH SIDE (LADO DE EMPUJE)

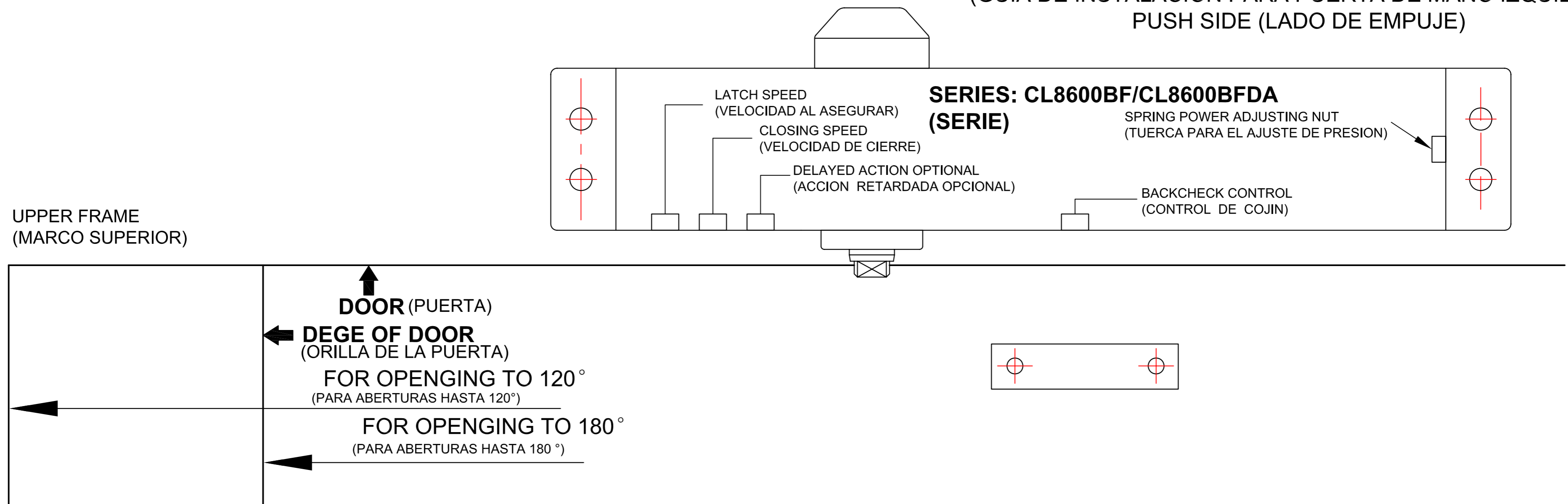

TOP JAMB APPLICATION
 (INSTALACION PARA SOPORTE SUPERIOR)
 TEMPLATE FOR A RIGHT HAND DOOR
 (GUIA DE INSTALACION PARA PUERTA DE MANO DERECHA)
 PUSH SIDE (LADO DE EMPUJE)

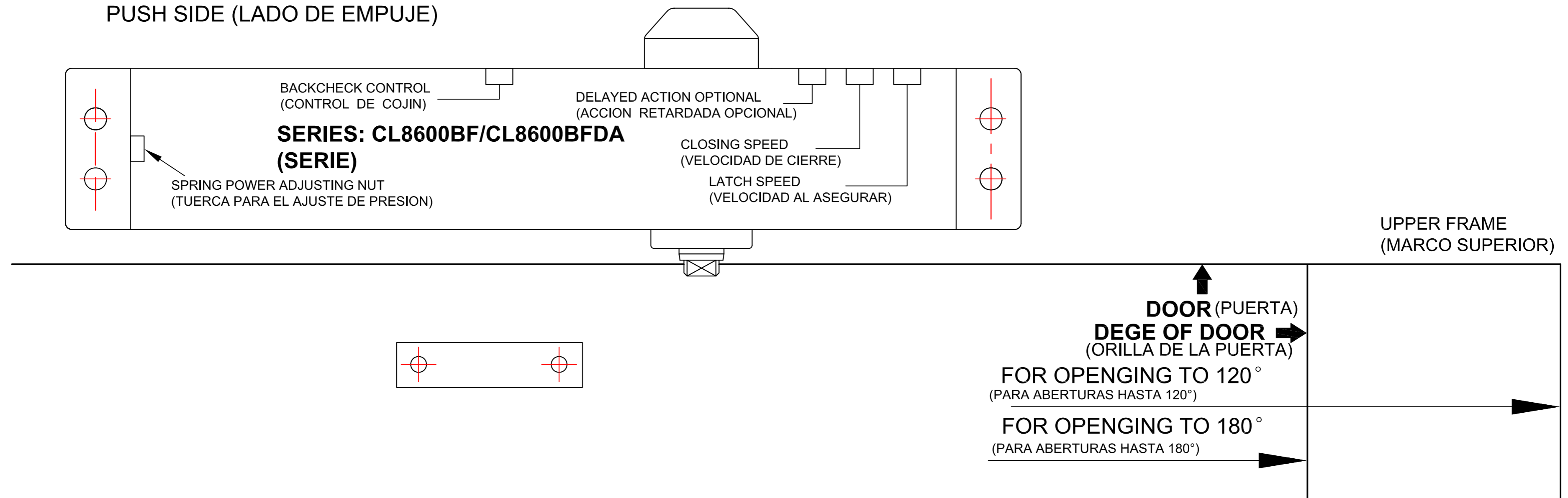

UPPER FRAME
(MARCO SUPERIOR)

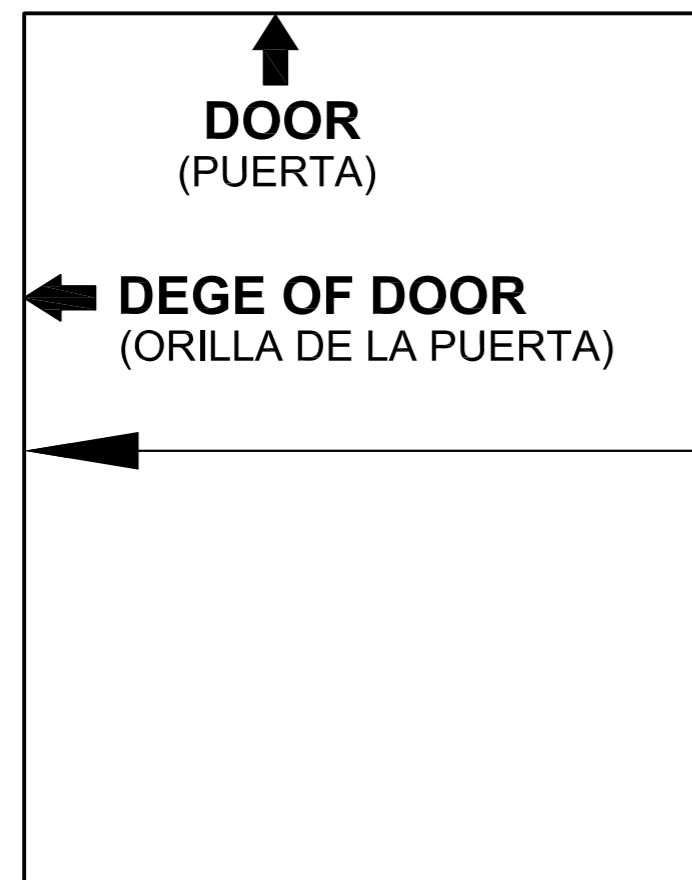
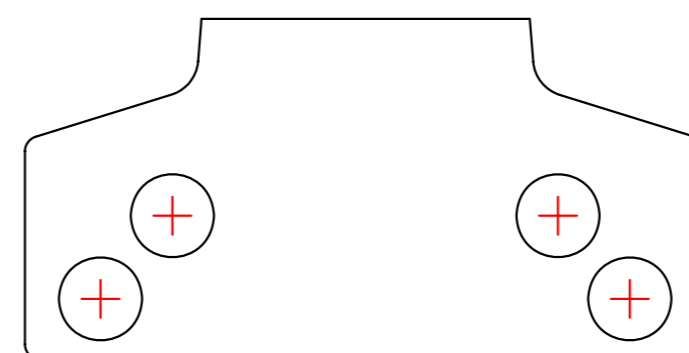

**PARALLEL ARM APPLICATION (INSTALACION PARALELA)
TEMPLATE FOR A LEFT HAND DOOR
(GUIA DE INSTALACION PARA PUERTA DE MANO IZQUIERDA)
PUSH SIDE (LADO DE EMPUJE)**

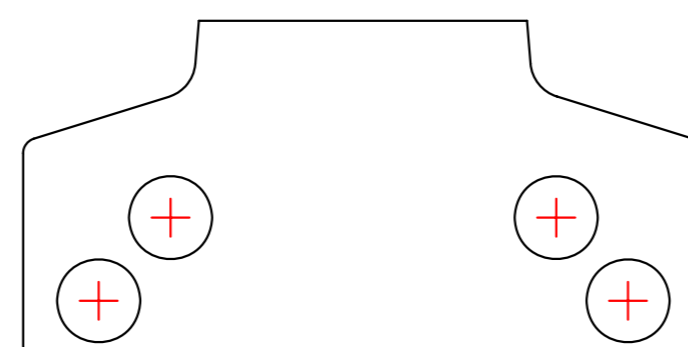
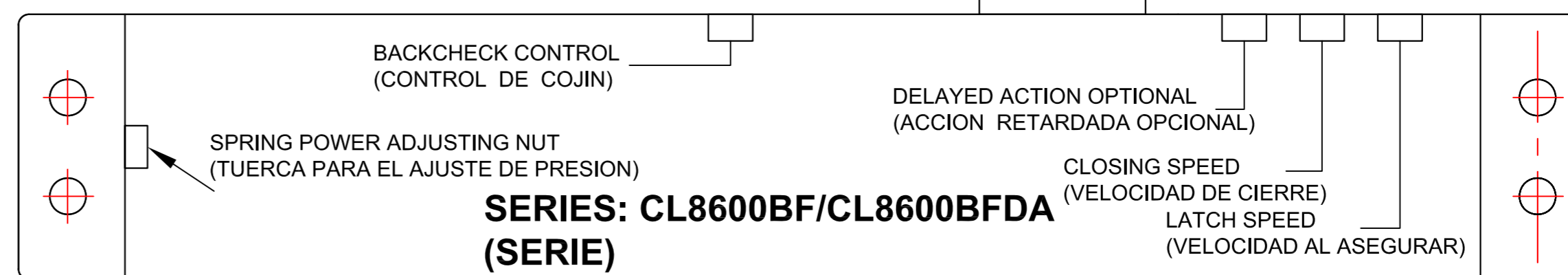

UPPER FRAME
(MARCO SUPERIOR)

**PARALLEL ARM APPLICATION (INSTALACION PARALELA)
TEMPLATE FOR A RIGHT HAND DOOR
(GUIA DE INSTALACION PARA PUERTA DE MANO DERECHA)
PUSH SIDE (LADO DE EMPUJE)**

FOR OPENING TO 180°
(PARA ABERTURAS HASTA 180°)

FOR OPENING TO 120°
(PARA ABERTURAS HASTA 120°)

